

FIJACIÓN VIDRIO / PARED REGULABLE

Ø 35 mm

Taladro avellanado

Vidrio 10/16 mm

Acabados:

Salida 25/30 mm	Inox brillo Inox mate	897 IB 897 IM
Salida 30/35 mm	Inox brillo Inox mate	898 IB 898 IM

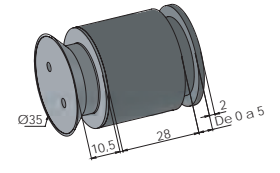
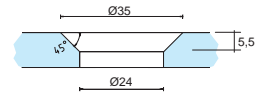
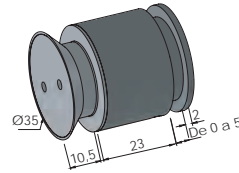

3247.3
3248.3

FIJACIÓN VIDRIO / PARED REGULABLE

Ø 35 mm

Vidrio 10/16 mm

Acabados:

Salida 25/30 mm	Fijación frontal	Inox brillo Inox mate	899.5 IB 899.5 IM
	Fijación lateral	Inox brillo Inox mate	899.6 IB 899.6 IM
Salida 30/35 mm	Fijación frontal	Inox brillo Inox mate	899.7 IB 899.7 IM
	Fijación lateral	Inox brillo Inox mate	899.8 IB 899.8 IM



3247.1
3247.2
3248.1
3248.2

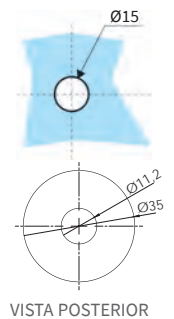
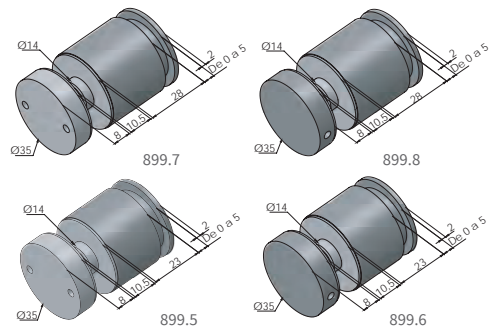

FIJACIÓN VIDRIO / PARED

Mediante taco químico y varilla roscada M10

Vidrio 8/16 mm

Acabados:

Salida 30 mm	Inox brillo Inox mate	891 IB 891 IM
Salida 45 mm	Inox brillo Inox mate	891.1 IB 891.1 IM
Salida 60 mm	Inox brillo Inox mate	891.2 IB 891.2 IM

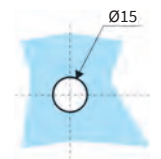
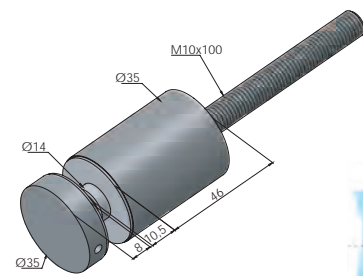

3275.1
3275.2
3275.3